

### Composites

## SANIGRID® ceiling grid system

**CLASS A FIRE RATING** PER ASTM E-84

### PRODUCT

Sanigrid II, the all-fiberglass ceiling grid system, is known for its moisture and corrosion resistance in high humidity installations. It won't rust, pit, dent, or peel like metal grid systems.

### CERTIFICATIONS

Meets requirements of major model building codes for Class A interior wall and ceiling finishes of flame spread  $\leq 25$ , smoke developed 450 or less (per ASTM E-84) (see flame and smoke development rating information).

### LIMITATIONS

Sanigrid II has not been tested for compliance with seismic ceiling grid requirements.

FRP panels and grid will discolor when installed near any heat source which radiates temperatures exceeding 130°F (55°C), such as cookers, ovens, and deep fryers. Do not install near heat sources exceeding 130°F (55°C).

Prolonged exposure to cooking smoke may result in embedded stains that will be difficult to remove.

Light fixture lens door dimensions should be compared to grid opening dimensions to validate compatibility.

### LOAD SPAN RATING (per ASTM C-635)

| HANGER WIRE SPACING | MAXIMUM FOR 2'x4' TILE | RATING       |
|---------------------|------------------------|--------------|
| 4 ft/oc   1.2 m/oc  | 20 lb.                 | Light Duty   |
| 2 ft/oc   0.6 m/oc  | 40 lb.                 | Intermediate |
| 1 ft/oc   0.3 m/oc  | 60 lb.                 | Heavy Duty   |

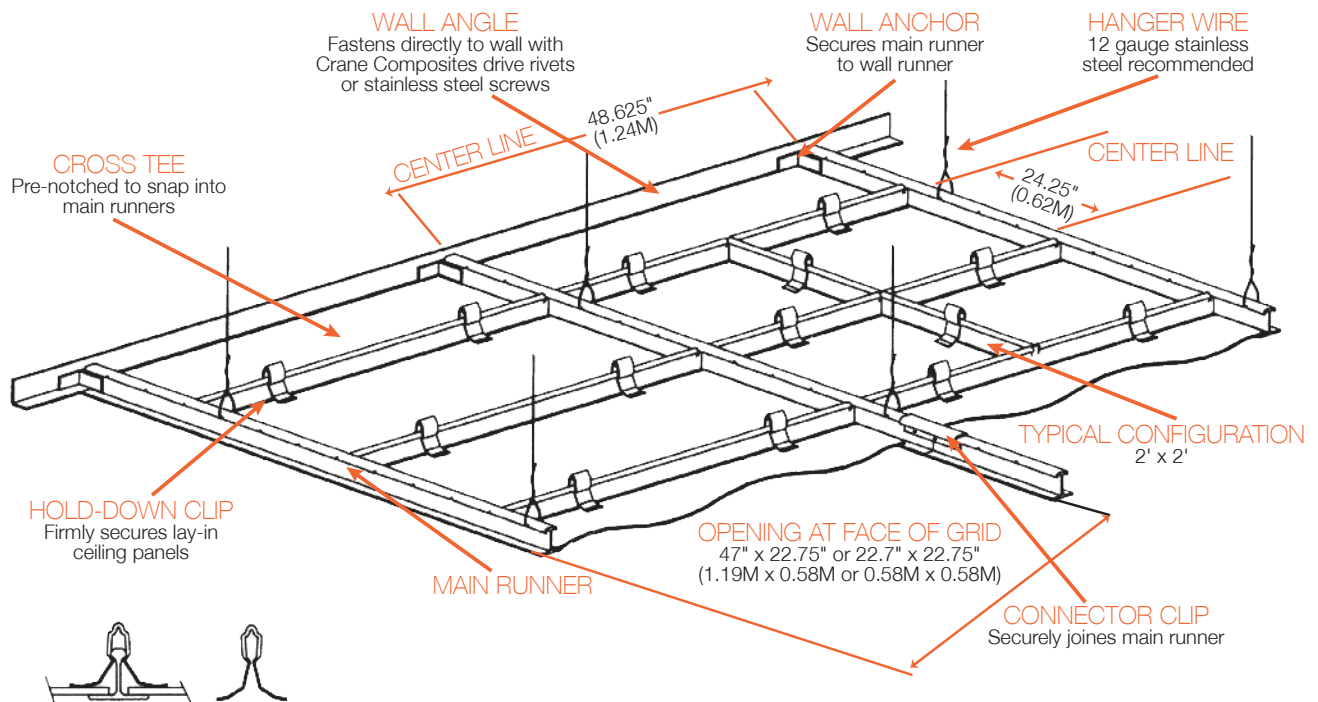

**PART NAMES AND NUMBERS**

All over length dimensions have a tolerance of +0.20"

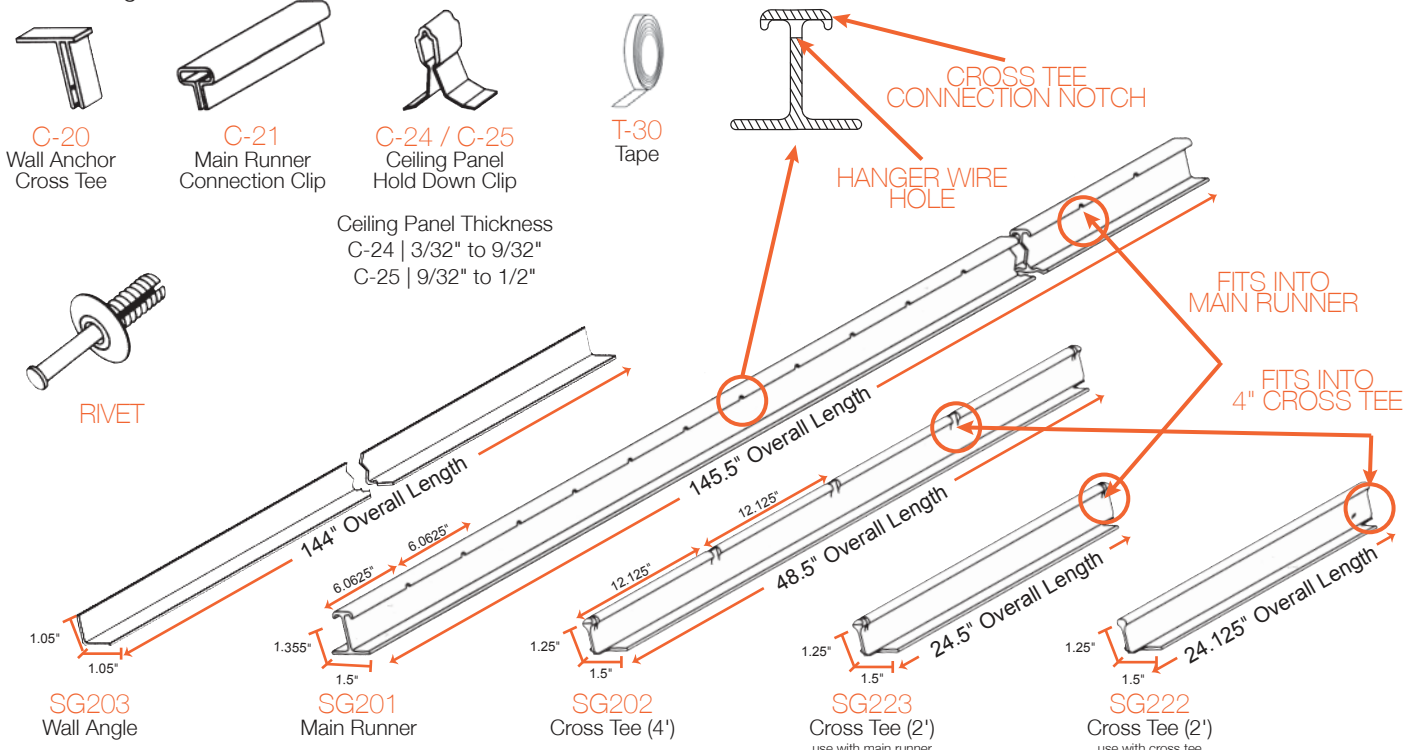

**WALL ANCHOR CROSS TEE | C-20**

Wall anchors are available to secure the main runner and cross tees to the wall angle. Industrial double-faced tape also available in lieu of screws to attach the wall anchor.

**MAIN TEE SPLICE | C-21**

The Main Tee Splice is used to securely join two main runners.

**RIVET | R52501/R52502/R52503/R52507**

R52503 | 3/4" R52501 | 1" R52502 | 1 1/2" R52507 | 2"  
 Not included with standard installation kit, purchased separately.

**WALL ANGLE | SG203**

1" x 1" wall angles come cut in standard 12' lengths to fasten directly to the wall.

**CEILING PANEL HOLD DOWN CLIP | C-24/C-25**

C-24 for panels 3/32" - 9/32" C-25 for panels 9/32" - 1/2"  
 Hold down clips are intended only to hold ceiling panels in position. They will not prevent panel warping under severe environmental conditions.

**MAIN RUNNER | SG201**

Main runners come in 12' 1 1/2" lengths. Notches for cross tee attachments and hanger wires are 6-1/16" on center.

**CROSS TEE | SG202/SG222/SG223**

SG202 - 48 1/2" pre-notched to snap into main runners.  
 SG223 - 24 1/2" to mate with the main runners.  
 SG222 - 24" nests between 4' cross tees.

| PART # ID      | COLOR | LENGTH         | DESCRIPTION                                   | SOLD IN FULL BOX/BAG QT |
|----------------|-------|----------------|---|-------------------------|
| <b>R51512</b>  | White | 12 FT          | SG201 - Main Tee                              | 20                      |
| <b>R51513</b>  | White | 4 FT           | SG202 - 4 FT Cross Tee*                       | 30                      |
| <b>R51514</b>  | White | 2 FT           | SG - 222 - 2 FT Cross Tee                     | 30                      |
| <b>R51522*</b> | White | 2 FT           | SG223 - 2 FT Cross Tee (main tee connection)* | 30                      |
| <b>R51519</b>  | White | 12 FT          | SG203 - Wall Angle                            | 20                      |
| <b>R51516</b>  | White | Not Applicable | C-20 - Wall Anchor                            | 100                     |
| <b>R51515</b>  | White | Not Applicable | C-21 - Connector Clip                         | 100                     |
| <b>R51517</b>  | White | Not Applicable | C-24 - Hold-Town Clip Panels 3/32" to 9/32"   | 100                     |
| <b>R51518</b>  | White | Not Applicable | C-25 - Hold-Town Clip Panels 9/32" to 1/2"    | 100                     |
| <b>R51521</b>  | White | Not Applicable | T-30 - Double Face Tape to Attach Wall Anchor | 216 FT Roll             |

Reference Sanigrig II Calculator at [www.cranecomposites.com/bp/sanigrigconfig.html](http://www.cranecomposites.com/bp/sanigrigconfig.html)

\*Cross Tee SG223 is designed to interlock with the main tee and is used only where main tees are spaced 2' on center. THESE TEES ARE A NON STOCKED SPECIAL ORDER ITEM WITH A 4 WEEK LEAD TIME.

\*\*Non-standard oversize ceiling panels (23.75" x 48" and 23.75" x 24" - use with 2ft cross tee SG223) are available to prevent ceiling panel from shifting. These panels will not fit standard metal grid systems.

**SANIGRID + GLASBORD CEILING PANEL SIZES**

| GRID SIZE                  | 5/8"   15.9mm or less           | 3/4"   19.1mm   | 1"   25.4mm and over            |
|----------------------------|---------------------------------|-----------------|---------------------------------|
| A<br>2' x 4'   0.6m x 1.2m | 23-3/4" x 48"   0.6m x 1.2m     | Not Recommended | 23-3/4" x 47-1/2"   0.6m x 1.2m |
| B<br>2' x 2'   0.6m x 0.6m | 23-3/4" x 23-3/4"   0.6m x 0.6m | Not Recommended | 23-3/4" x 47-1/2"   0.6m x 1.2m |
| C<br>2' x 2'   0.6m x 0.6m | 23-3/4" x 24"   0.6m x 0.6m     | Not Recommended | 23-3/4" x 47-1/2"   0.6m x 1.2m |

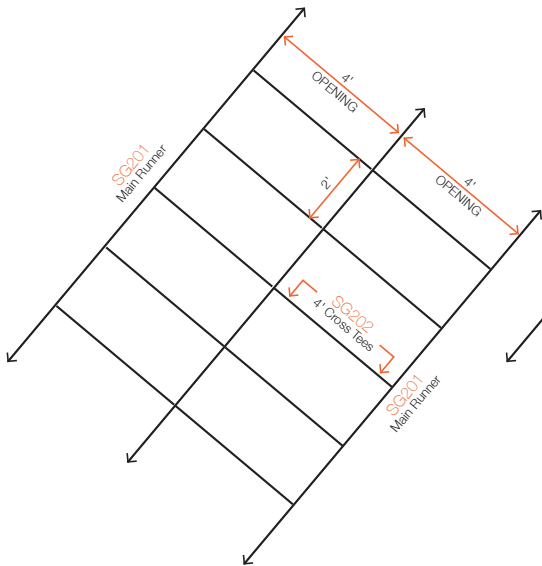

FIGURE A

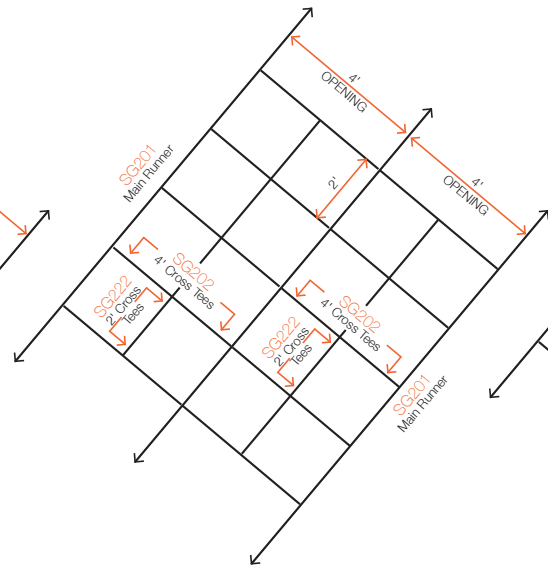

FIGURE B

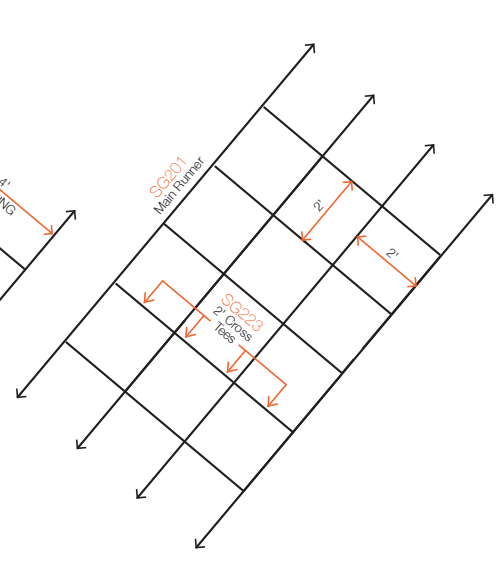

FIGURE C

- A. Grid configured with main tees 4' O.C. and 4' cross tees interlocking main tees.
- B. Grid configured with main tees 4' O.C. and 4' cross tees interlocking main tees and 2' cross tees (SG222) intersecting 4' tees.
- C. Grid configured with main tees 2' O.C. and 2' cross tees (SG223) interlocking main tees.

**IMPORTANT INSTALLATION NOTES**

The main runner notches and cross tee lengths have been sized to provide a 23¾" x 47¾" or 23¾" x 23¾" opening at the top of the grid.

As a result the main runners are 48" on the center and the cross tees are 24¼" on center. This will provide clearance for laminated, rigid, or gypsum ceiling panels, light fixtures or air diffusers. THIS MAY AFFECT CEILING LAY-OUT.

To accommodate the over-size dimensions of the Sanigridd II ceiling system, 23¾" x 48" Glasbord ceiling panels are available and required. These panels WILL NOT FIT standard metal grid systems so they should be ordered only for Sanigridd II installations. The standard 23¾" x 23¾" panels will fit the 2' x 2' Sanigridd II system.

Before beginning installation, ensure that you have the correct cross tee to match your ceiling layout. Two different 2' cross tees are available. The SG222 is designed to mate with the 4' cross tee. The SG223 is designed to mate with the 12' main runner.

To accommodate light fixtures and other ceiling inserts, the Sanigridd II main runners are spaced 48.60" on center and the 4' cross tees are spaced 24.25" on center. This spacing will provide a 23-3/4" x 47-3/4"

or 23-3/4" x 23-3/4" opening at the top of the grid. This may affect ceiling layout. Check component sizes (above and below) and center lines before laying out ceiling plan. This may also affect light fixture positions and other trades above the ceiling line.

Light fixtures must be supported independent of the ceiling grid system. Opening at face of grid for light fixture lens door is 47" x 22-3/4" or 22-3/4" x 22-3/4".

**CAUTION**

When cutting, drilling, or grinding fiberglass materials, protect eyes with goggles.

Wear a filter mask to avoid breathing dust, and wear gloves to prevent splinters.

A hacksaw is recommended for hand cutting ceiling system

**FABRICATING RECOMMENDATIONS**

Prior to working with our products, see our most current SDS at [cranecomposites.com/sds.html](http://cranecomposites.com/sds.html)

**FLAME SPREAD AND SMOKE DEVELOPMENT RATINGS**

The numerical flame spread and smoke development ratings are not intended to reflect alleged hazards presented by Crane Composites products under actual fire conditions and this product has not been tested by Crane Composites except as set forth below. These ratings are determined by small-scale tests conducted by Underwriters Laboratories and other independent testing facilities using the American Society for Testing and Materials E-84 test standard (commonly referred to as the "Tunnel Test").

CRANE COMPOSITES PROVIDES THESE RATINGS FOR MATERIAL COMPARISON PURPOSES ONLY. Like other organic building materials (e.g. wood), panels made of fiberglass reinforced plastic resins will burn. When ignited, FRP may produce dense smoke very rapidly. All smoke is toxic. Fire safety requires proper design of facilities and fire suppression systems, as well as precautions during construction and occupancy. Local codes, insurance requirements and any special needs of the product user will determine the correct fire-rated interior finish and fire suppression system necessary for a specific installation. We believe all information given is accurate, without guarantee. Since conditions of use are beyond our control, all risks are assumed by the user. Nothing herein shall be construed as a recommendation for uses which infringe on valid patents or as extending a license under valid patents. [www.astm.org/Standards/E84.htm](http://www.astm.org/Standards/E84.htm).

# STEP BY STEP INSTALLATION INSTRUCTIONS

## Step 1

Install Sanigrid II wall angle at desired height around perimeter of room in the usual manner. Use non-corrosive fasteners appropriate for wall material. Pre-drill appropriate size hole for fastener.



## Step 2

Install hanger eyes and wire at appropriate spacing per chart. Use galvanized anchors and 12 ga. galvanized metal, or stainless steel wire. (Use corrosion-resistant materials suitable for the intended environment).

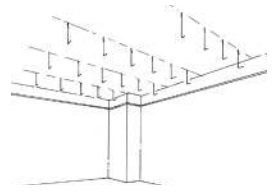

## Step 3

Secure main runners to hanger wires and make leveling adjustments. Where main tees butt, secure with connector clip. Additional holes may be drilled in main tees as required for proper alignment with hanger wires. Space holes no closer than 4" (102 mm) from end of tee or another hole.

**IMPORTANT: LIGHT FIXTURES MUST BE INSTALLED TO HANG INDEPENDENTLY OF THE GRID SYSTEM.**



## Step 4

Where the main runner meets the wall angle, cut away the face of the runner so that the vertical web will rest on the wall angle. Scoring the runner on both sides of the vertical and horizontal web will assist in providing a clean break.



## Step 5

Install a wall anchor clip or use the T-30 tape to affix the C-20 clip to the wall angle and a diagonal hanger wire. This will prevent shifting and misalignment of the main runners.

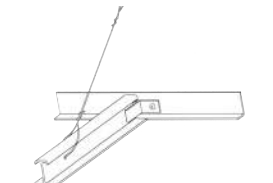

## Step 6

Install cross tees by positioning tee at the cross tee notch on the main tee. Both ends must be positioned at the same time. Then simply twist the cross tee into position. At the cross tee wall angle junction, cut away the face and install wall anchor as was done for the main runners.



## Step 7

Install lay-in ceiling panels in the usual manner.



## Step 8

Install two hold down clips along the cross tees only. Hold down clips are intended only to hold panels in position. They will not prevent warping under severe conditions.



A global leading provider of resilient wall and ceiling coverings. Kemlite® was established in 1954 and the company changed names to Crane Composites in 2007. Crane Composites is headquartered in Channahon, IL and all our products are manufactured in the United States. We work with hundreds of distributors, ensuring our products are easily accessible and readily available to our customers.

The following are trademarks of Crane Composites, Inc. or a related company: Glasbord, Kemlite, Kemply, Surfaseal, Sanigrid, Silhouette Trims and Varietex

